



CUNOVA

FORMERLY KME
SPECIAL PRODUCTS
& SOLUTIONS



Moulds

for Casting nonferrous Alloys



MELTING & CASTING
TECHNOLOGIES

CONTENT

| | |
|--|----|
| The Company | 03 |
| Engineered Products for Melting and Casting | 05 |
| Research & Development and Engineering | 06 |
| Mould Materials for nonferrous Casting | 08 |
| cunova-Materials for Casting Wheels | 09 |
| cunova-Materials for dam Blocks | 10 |
| cunova-Materials for Casting Sleeves | 11 |
| Properties and Applications of cunova nonferrous Mould Alloys | 12 |
| cunova Mould Materials for Casting Wheels | 14 |
| cunova Mould Materials for dam Blocks and Casting Sleeves | 16 |
| Nonferrous Moulds Manufacturing | 18 |
| cunova after-sales Service | 20 |
| Typical Shapes | 22 |
| Manufacturing Range of cunova Casting Wheels | 23 |

The Company

cunova's corporate goal is to develop and manufacture products that meet customer demands, finding solutions for their specific applications, and providing services as a long-term partner. cunova's strategy for accomplishing this goal is based on a highly skilled and experienced workforce. cunova has the ability to invent and develop new materials and innovative production processes via ongoing advancement and training of our employees and the continual improvement of its organisational structures.





Innovative Products for Melting & Casting

The Melting & Casting Technologies Division was formed with the aim of providing flexible solutions to the changing market demands and improving the customer orientation of our business. Our customers are producers of nonferrous metals, casting machine builders and maintenance companies throughout the world.

Continuous casting of nonferrous alloys has seen major improvements in terms of quality and economics of operation over the past decades. This success is based on improvements in casting machine design, mould design and materials.

The advances in nonferrous alloys casting were made possible by the further development of high-performance moulds made of copper materials. CUNOVA was involved in these developments right from the very beginning and has continued to set milestones in the development and production of casting wheels, dam blocks and casting sleeves which have undertaken an evolution of their own.

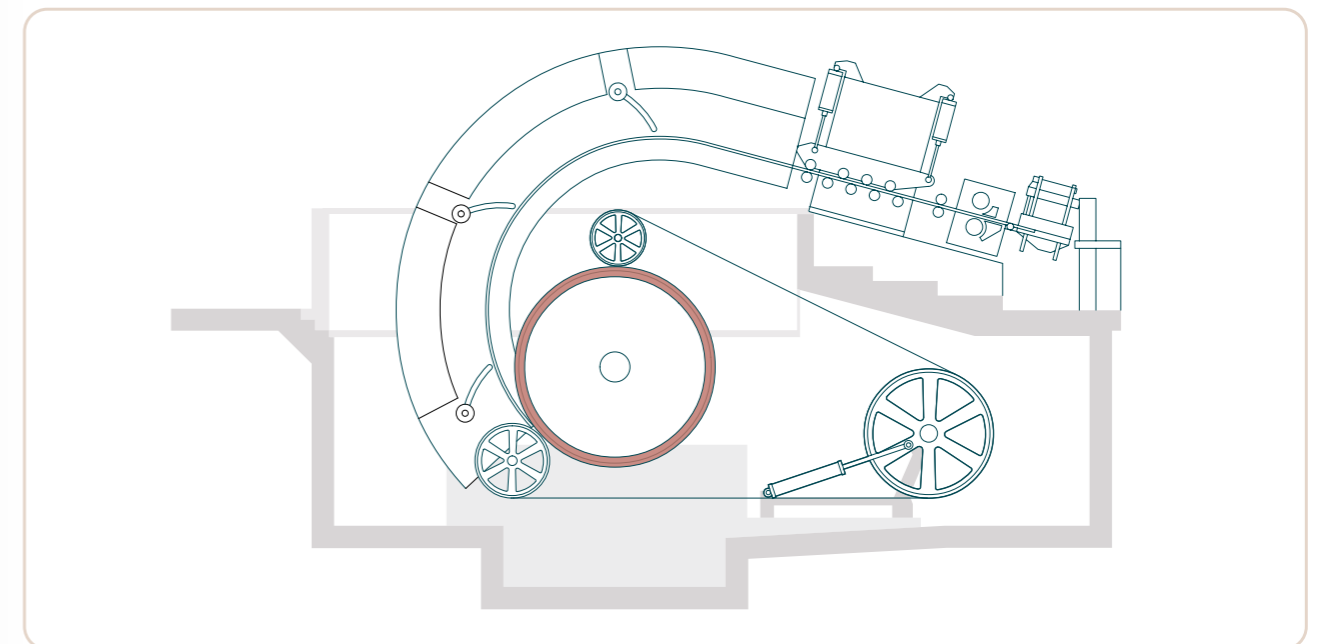

Continuous casting technology with casting wheels

Research & Development and Engineering

The goal of our work is to constantly improve our products for the benefit of our customers. To this end, cunova is working on new materials and materials processing. The R&D department has been set up in such a way that it can deal with the complete range of assignments, from developing new mould materials right through to supporting the application of newly developed moulds.

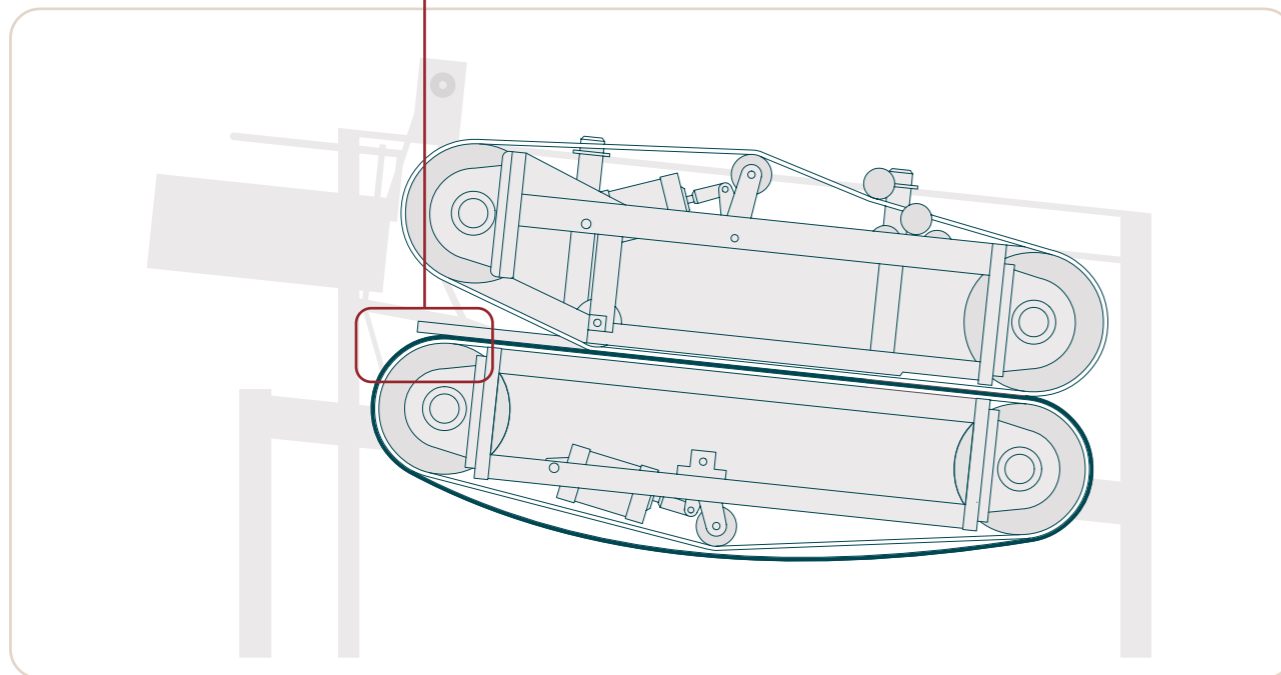
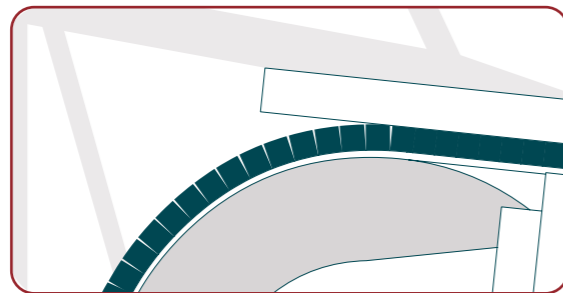

Continuous casting technology with dam blocks

The development of new materials involves testing new compounds as well as the further development of known ones. The R&D department for material development solves both tasks. In addition, cunova can provide detailed engineering support on the design of moulds or the adjustment of cooling conditions. For this purpose cunova conducts FEM calculations to allow a detailed thermal and mechanical stress analysis. On request cunova will also do the detail engineering based on the plant maker's drawings.

The laboratory's melting and casting facilities are capable of casting blocks which can be further processed in the production facilities. This means that the optimal production parameters can be determined in advance. A rolling mill and a press, together with annealing and salt-bath furnaces, are used for thermo-mechanical treatments within the department.

The development of materials is supported by the full range of chemical analysis (S-OES, XRS, ICP, GF-AAS,

etc.) including metallography and by SEM/TEM electron microscopes, including EDX/WDX analysis systems. The technological laboratories for physics and mechanics are equipped with all of the necessary devices for testing and measuring (including tests on creep, relaxation, softening, fatigue resistance, etc.).

Destructive tests provide additional data, making it possible to compile customer-specific information on particular stresses such as thermal/chemical problems.

Today, basic laboratory work is supplemented by development work for the customer, focusing on high casting speeds accompanied by the highest reliability and service life of the moulds in the industrial applications.

Thus, the primary concern of all development activities carried out by cunova is to provide technical support to customers on how to optimise their facilities, processes and products.

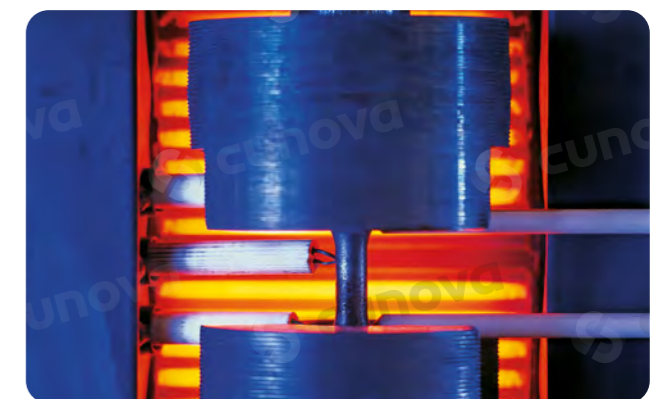
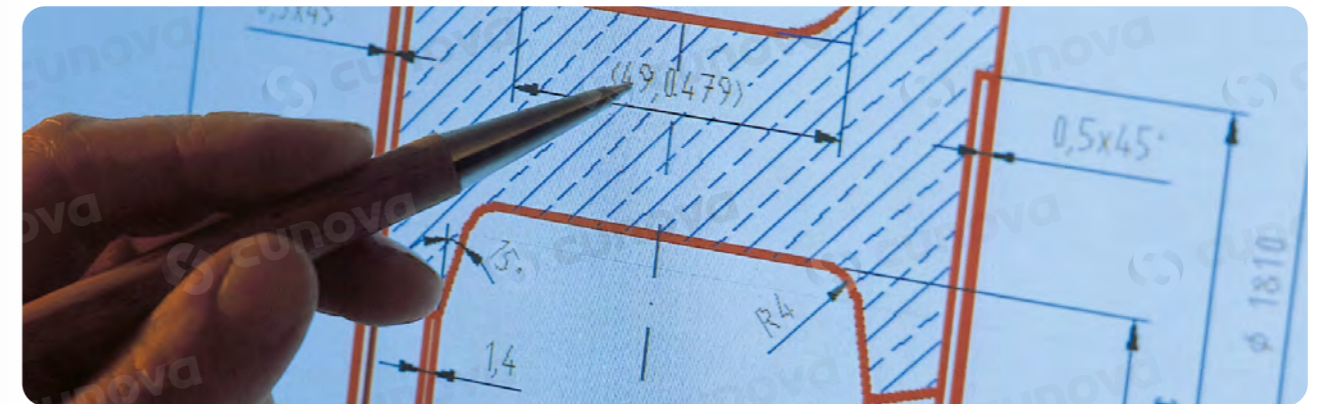

Mould Materials for nonferrous Casting

Copper and Copper Alloys for nonferrous Moulds

Material sciences and the development of copper alloy systems have for many years represented an important area for cunova as the leading manufacturer of copper products. A major part of cunova's effort in these fields is dedicated to the development of copper alloy systems for moulds.

In contrast to most of the steel continuous casting applications where the mould is subject to quasi-stationary stresses, nonferrous casting mostly results in a transient, cyclical stress in the mould (wire cast process, Hazelett) and to the mould material. Special balanced materials and appropriately adapted manufacturing and thermal handling processes are required to achieve optimal, economical service life under such conditions.

In this regard, the following properties are particularly significant for optimal service behaviour:

- high hardness and strength
- high thermal conductivity
- high hardness and tensile strength at elevated temperatures
- high softening and recrystallisation temperatures
- high thermal-mechanical fatigue strength

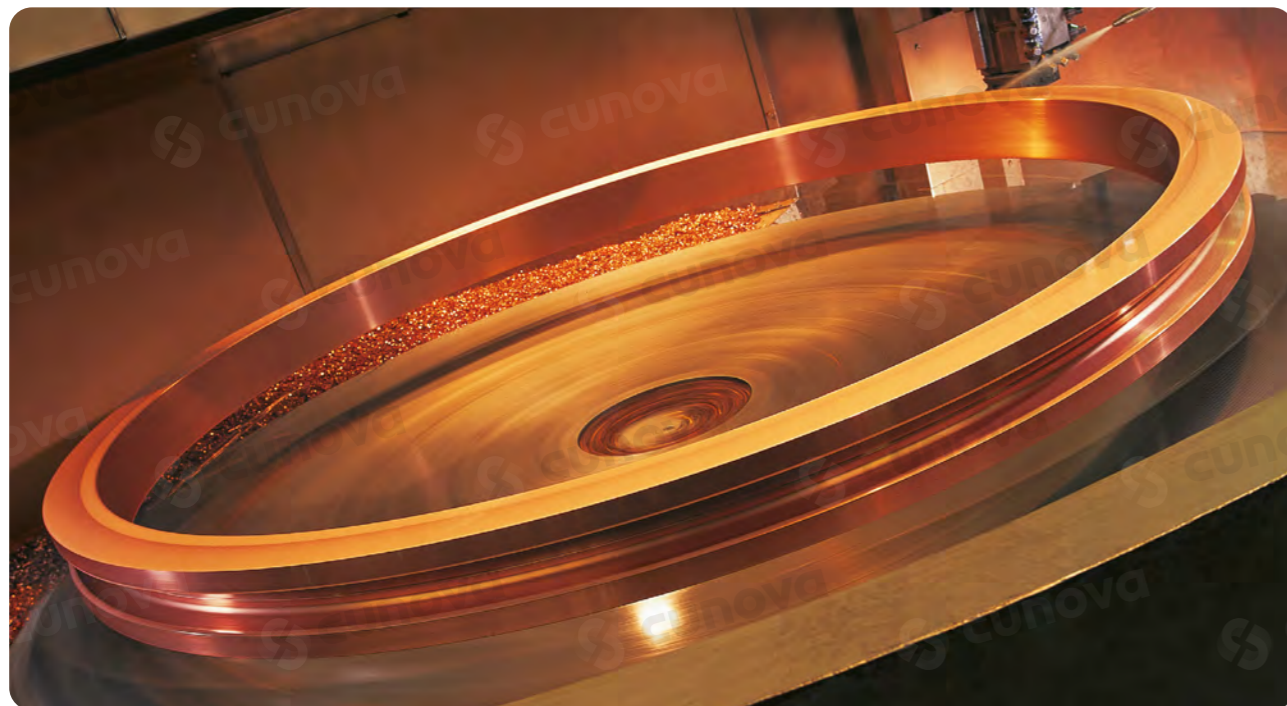

cunova-Materials for Casting Wheels

Today cunova casting wheels are used throughout the world in all types of plants. In order to optimise the service life of the casting wheel, and with regard to the specific stresses encountered in the operation, cunova has developed the materials CuAg, ELBRODUR® G and ELBRODUR® GF.

CuAg

Copper silver (CuAg/DPS-Cu) casting wheels are used for applications with medium to high stress such as occur when casting aluminium wire. The alloy has a high thermal conductivity and very good tensile strength properties.

ELBRODUR® G

ELBRODUR® G is a special cunova material developed for mould applications. In addition to high tensile strength, the precipitation hardened CuCrZr alloy exhibits very good thermal conductivity and elevated softening temperatures, as well as high thermal fatigue strength. Casting wheels made of ELBRODUR® G are used throughout the world on wire casting equipment for casting copper and aluminium.

ELBRODUR® GF

The material, ELBRODUR® GF, is a further development of the ELBRODUR® G material that is specially engineered to casting wheel applications. The fatigue strength of this material is up to double that of the standard alloy, while the very good

electrical/thermal conductivity values are maintained. The excellent property combination of this alloy is achieved through special alloy adjustment of the elements and a fine-tuned thermo-mechanical treatment. Service life improvements of 60–100 % were achieved with ELBRODUR® GF casting wheels in applications for copper wire casting equipment.

Fatigue strength of cunova mould materials at elevated temperatures

■ 200 °C
■ 350 °C

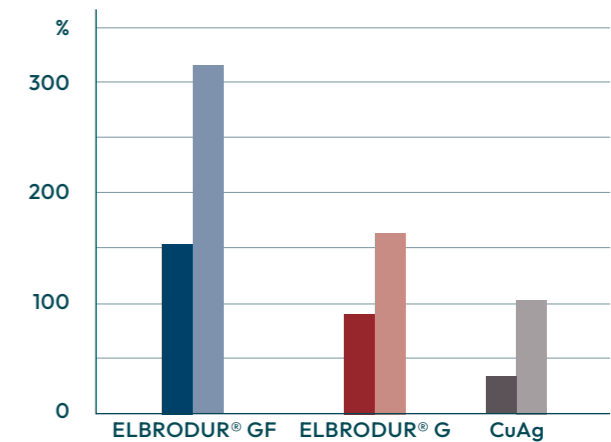

cunova-Materials for dam Blocks

The extreme stresses to which dam blocks are subjected when opening and closing the belt during a rotation require high strength and hardness to prevent premature mechanical wear. At the same time, the material must have good thermal conductivity for high speed casting applications, and must not be sensitive to the formation of thermal shock cracks.

OSNISIL® G

The cunova developed alloy OSNISIL® G, a material for dam blocks used in twin-belt type continuous casting machines, is the perfect solution for the required properties mentioned above. It offers a high basic physical strength and hardness as well as the necessary thermal

conductivity and fatigue strength to prevent cracking in the T-slot zone, even when exposed to extreme thermal shocks as experienced, for example, during the short-term standstill of the machine. As a result, cunova dam blocks offer a high degree of safety.

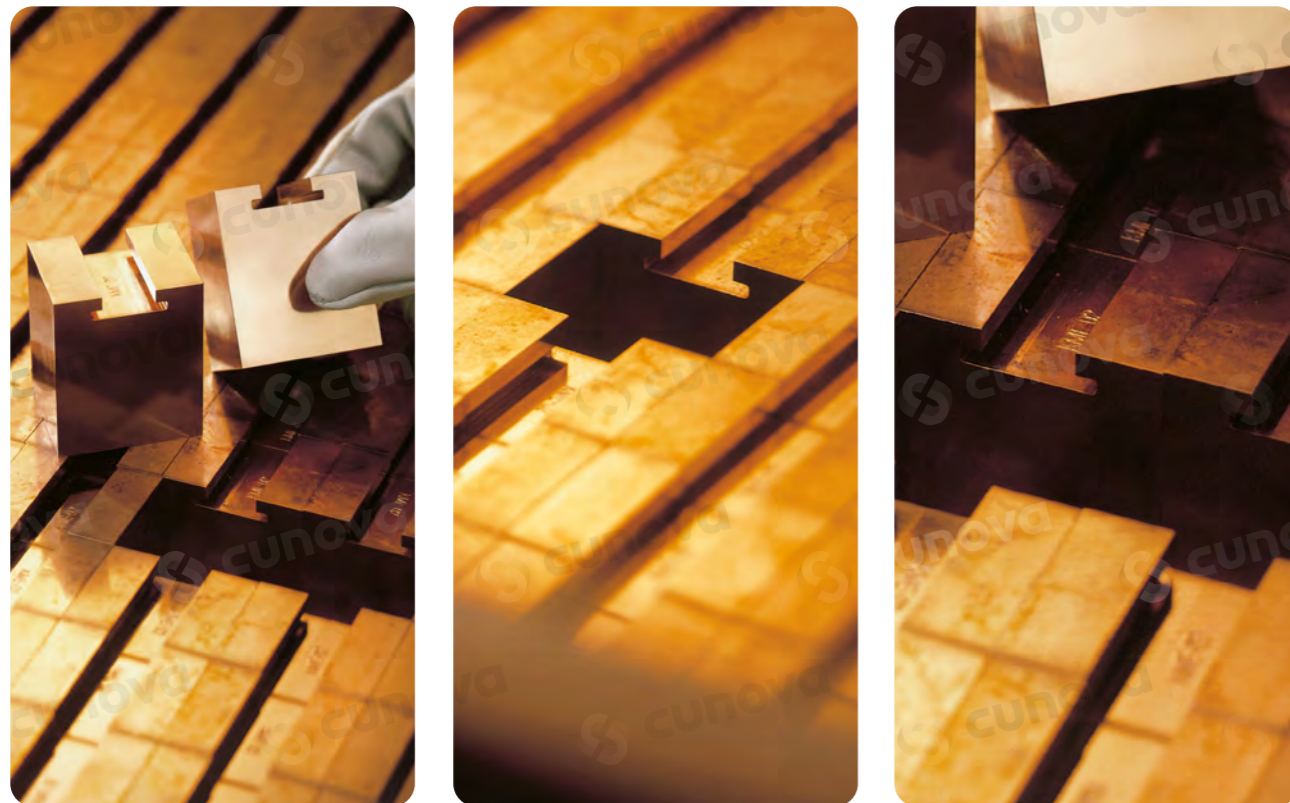

cunova-Materials for Casting Sleeves

Moulds are subject to high thermal and mechanical fatigue stresses when casting nonferrous metals in (thin) strip casting. Mould materials for such applications must satisfy high strength requirements even at elevated temperatures. At the same time, a minimum ductility is required to prevent cracks in the material from spreading.

ELBRODUR® G

Precipitation hardened ELBRODUR® G, a material based on CuCrZr, offers distinct advantages for applications with casting sleeves. It offers distinctly higher strength, hardness and ductility – together with very high electrical conductivity of approximately 83 % IACS. Its favourable combination of properties makes it a material ideally suited for the manufacturing of casting sleeves.

ELBRODUR® B 95

ELBRODUR® B 95 is a highly developed, state-of-the-art, CuCoBe alloy which obtains its particular properties by way of precipitation hardening and a special thermo-mechanical processing. The material possesses a medium thermal conductivity, and excellent thermal and mechanical properties which it retains even at high temperatures.

ELBRODUR® NIB

This is a newly developed material based on CuNiBe. It has been developed specifically for use in moulds for near-net-shape casting and other moulds that need to withstand particularly high stresses.

Its outstanding characteristics are high strength along with medium conductivity, and it has a special resistance to cracking when exposed to thermal stresses caused by large temperature fluctuations in the mould wall.

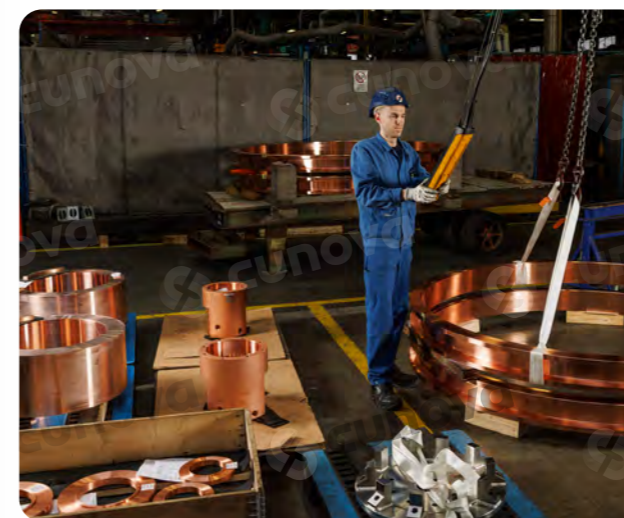

Properties and Applications of cunova Nonferrous Mould Alloys

| Material | CuAg | ELBRODUR® G | ELBRODUR® GF | OSNISIL® G | ELBRODUR® B 95 | ELBRODUR® NIB |
|---------------------------|----------------|-----------------------------------|----------------|------------|-----------------|-----------------|
| Thermal conductivity | High | High | High | Medium | Medium | Medium |
| Softening/ Recryst. temp. | Medium | Very high | Very high | Very high | Very high | Very high |
| Strength/ Hardness | Medium | High | High | Very high | Very high | Very high |
| Application | Casting wheels | Casting wheels Casting sleeves | Casting wheels | Dam blocks | Casting sleeves | Casting sleeves |



Figure 1
Recrystallisation/softening behaviour of cunova casting wheel materials

— CuAg
— ELBRODUR® G/GF
— ELBRODUR® B 95/NIB

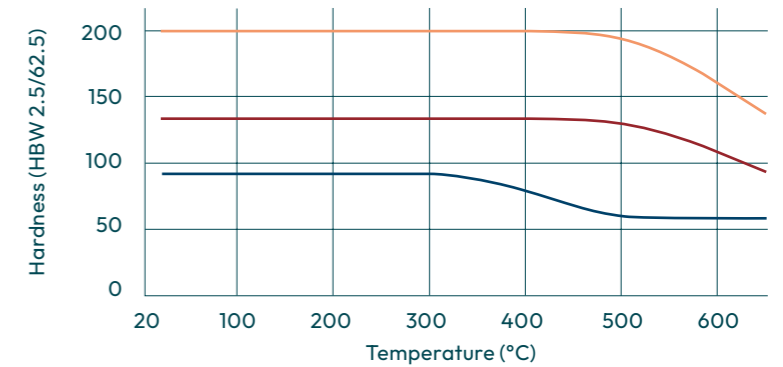

Figure 2
Creep characteristics of mould materials (temperature 200 °C / 392 °F, stress 150 MPa)

— CuAg
— ELBRODUR® G/GF

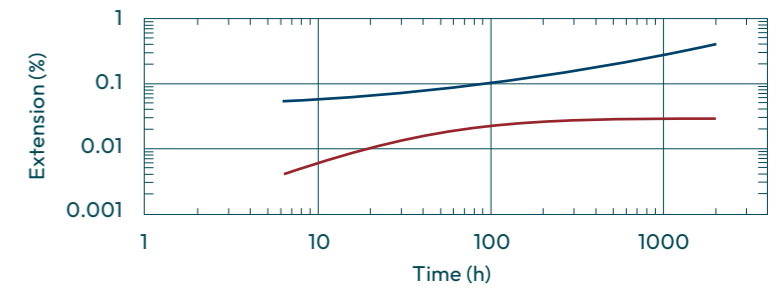

Figure 3
Hardness and electrical conductivity of cunova mould materials

■ Brinell hardness
HBW 2.5/62.5
■ Electrical conductivity
% IACS

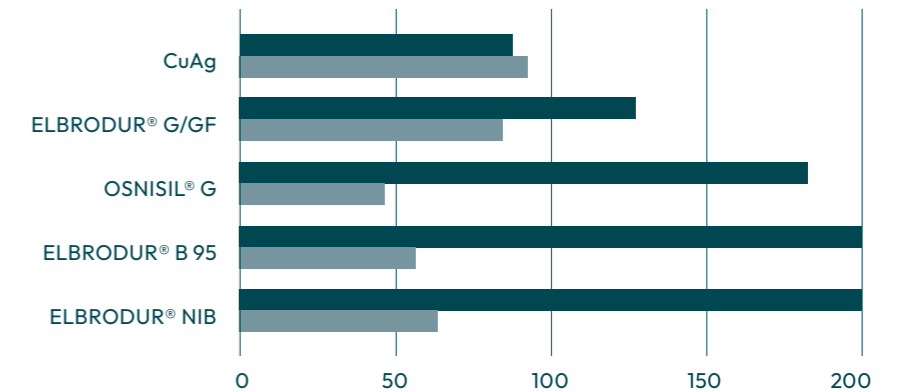
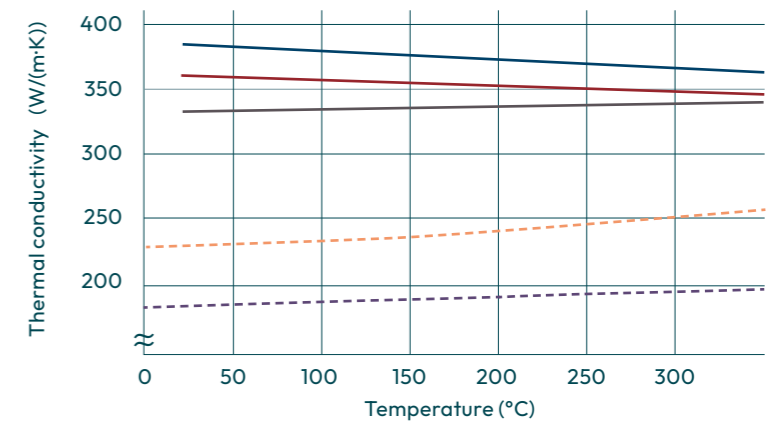

Figure 4
Effect of temperature on thermal conductivity of cunova mould materials

— CuAg-GS/NS
— ELBRODUR® G/GP/GP-NS/GD-NS
— Cu-GS
- - - ELBRODUR® B 95
- - - ELBRODUR® NIB



cunova Mould Materials for Casting Wheels

| Material Properties* | Temperature | | Units | CuAg | ELBRODUR® G w | ELBRODUR® GF |
|---------------------------------------|-------------|--|-------|---------|---------------|--------------|
| Chemical composition (without copper) | | | % | 0.09 Ag | 0.65 Cr | 0.65 Cr |
| | | | | 0.004 P | 0.1Zr | 0.1Zr |

| Physical Properties | °C | °F | | | | |
|----------------------------------|--------|--------|-----------------------|------|-----|-----|
| Electrical conductivity | 20 | 68 | S·m / mm ² | 56 | 48 | 49 |
| | | | % IACS | 96 | 83 | 85 |
| Thermal conductivity | 20 | 68 | W/(m·K) | 377 | 350 | 345 |
| Coefficient of thermal expansion | 20–300 | 68–572 | 10 ⁻⁶ / K | 17.7 | 18 | 18 |
| Recrystallisation temperature | - | - | °C | 370 | 700 | 700 |



| Material Properties* | Temperature | | Units | CuAg | ELBRODUR® G w | ELBRODUR® GF |
|---------------------------|-------------|----|---------------------|------|---------------|--------------|
| Softening temperature* ** | - | - | °C | | 590 | 590 |
| Modulus of elasticity | 20 | 68 | 10 ³ MPa | 125 | 128 | 128 |

| Mechanical Properties | °C | °F | | | | |
|-------------------------------------|-----|-----|------------|-------|-------|-------|
| 0.2% Proof stress R _{p0.2} | 20 | 68 | MPa | 270 | 255 | 340 |
| | 200 | 392 | | 255 | 240 | 310 |
| | 350 | 662 | | (195) | 220 | 270 |
| | 500 | 932 | | (30) | (200) | (230) |
| Tensile strength R _m | 20 | 68 | MPa | 285 | 390 | 420 |
| | 200 | 392 | | 260 | 340 | 380 |
| | 350 | 662 | | (200) | 280 | 320 |
| | 500 | 932 | | (90) | (220) | (260) |
| Elongation A ₅ | 20 | 68 | % | 18 | 27 | 22 |
| | 200 | 392 | | 14 | 25 | 20 |
| | 350 | 662 | | (10) | 23 | 18 |
| | 500 | 932 | | (40) | (21) | (16) |
| Hardness HBW | 20 | 68 | 2.5 / 62.5 | 90 | 120 | 130 |

Units: 1 MPa = 1 N/mm² = 0.102 kgf/mm² = 0.145 ksi; 1 W/(m·K) = 2.388 · 10³ cal/(cm·s·°C)

* Values may change with varying thermal and mechanical treatment due to geometry and manufacturing procedure

** Measurement according to DIN ISO 5182

() Values may change due to restricted reproducibility of measurement

cunova Mould Materials for dam Blocks and Casting Sleeves

| Material Properties* | Temperature | | Units | OSNISIL® G | ELBRODUR® G | ELBRODUR® B95 | ELBRODUR® NIB |
|---------------------------------------|-------------|--|-------|------------|-------------|---------------|---------------|
| Chemical composition (without copper) | | | % | 2.1 Ni | 0.65 Cr | 1.0 Co | 1.5 Ni |
| | | | | 0.7 Si | 0.1 Zr | 0.1 Be | 0.2 Be |
| | | | | 0.3 Cr | | | |

| Physical Properties | °C | °F | | OSNISIL® G | ELBRODUR® G | ELBRODUR® B95 | ELBRODUR® NIB |
|----------------------------------|--------|--------|---------------------|------------|-------------|---------------|---------------|
| Electrical conductivity | 20 | 68 | S·m/mm ² | 25 | 49 | 33 | 40 |
| | | | % IACS | 43 | 83 | 57 | 49 |
| Thermal conductivity | 20 | 68 | W/(m·K) | 185 | 350 | 240 | 290 |
| Coefficient of thermal expansion | 20–300 | 68–572 | 10 ⁻⁶ /K | 18 | 18 | 18 | 18 |
| Recrystallisation temperature | - | - | °C | (650) | (800) | (800) | (800) |
| Softening temperature*** | - | - | °C | 590 | 580 | 590 | 590 |
| Modulus of elasticity | 20 | 68 | 10 ³ MPa | 140 | 128 | 128 | 128 |

| Material Properties* | Temperature | | Units | OSNISIL® G | ELBRODUR® G | ELBRODUR® B95 | ELBRODUR® NIB | | | | |
|-------------------------------------|-------------|-----|----------------------------------|------------|-------------|---------------|---------------|-------|-------|-------|-------|
| | °C | °F | | | | | | | | | |
| 0.2% Proof stress R _{p0.2} | 21 | 68 | MPa | 500 | 270 | 490 | 510 | | | | |
| | 200 | 392 | | | | | | | | | |
| | 350 | 662 | | | | | | (440) | 230 | 430 | 470 |
| | 500 | 932 | | | | | | (350) | (200) | (400) | (420) |
| Tensile strength R _m | 20 | 68 | MPa | 650 | 390 | 630 | 630 | | | | |
| | 200 | 392 | | | | | | | | | |
| | 350 | 662 | | | | | | (470) | 280 | 500 | 540 |
| | 500 | 932 | | | | | | (370) | (220) | (440) | (430) |
| Elongation A ₅ | 20 | 68 | % | 17 | 25 | 13 | 12 | | | | |
| | 200 | 392 | | | | | | | | | |
| | 350 | 662 | | | | | | (3) | 22 | (5) | (4) |
| | 500 | 932 | | | | | | (2) | (20) | (3) | (3) |
| Hardness HBW | 20 | 68 | 2.5 / 62.5 / 187.5 ¹⁾ | | 125 | 200 | 200 | | | | |
| Hardness HV | 20 | 68 | HV 10 | 200 | | | | | | | |

Units: 1 MPa = 1 N/mm² = 0.102 kgf/mm² = 0.145 ksi; 1 W/(m·K) = 2.388 · 10³ cal/(cm·s·°C)

* Values may change with varying thermal and mechanical treatment due to geometry and manufacturing procedure

** Measurement according to DIN ISO 5182

() Values may change due to restricted reproducibility of measurement

¹⁾ Hardness HBW: 2.5/62.5 for ELBRODUR® G, 2.5/187.5 for ELBRODUR® B95 and ELBRODUR® NIB

Nonferrous Moulds Manufacturing

Melting and Casting

In cunova's melting and casting facilities, copper and copper alloys are produced on state-of-the-art systems. Cathodic, high-purity copper is mainly used for producing the materials and the composition of the melt is monitored by an analysis system. Billets and slabs can be cast on various casting systems in different geometries, so that the dimensions of the starting

material offer favourable properties for subsequent downstream production stages, e.g. when certain degrees of formability must be ensured for forging operations.



| Melting | | |
|-----------------|------------------|-----------------|
| Casting | | |
| ▼ | ▼ | ▼ |
| Hot forging | Hot forging | |
| Cold forging | Hot/cold rolling | Hot forming |
| Heat treatment | Heat treatment | Heat treatment |
| Machining | Machining | Machining |
| Quality control | Quality control | Quality control |
| Casting sleeve | Casting wheel | Dam block |

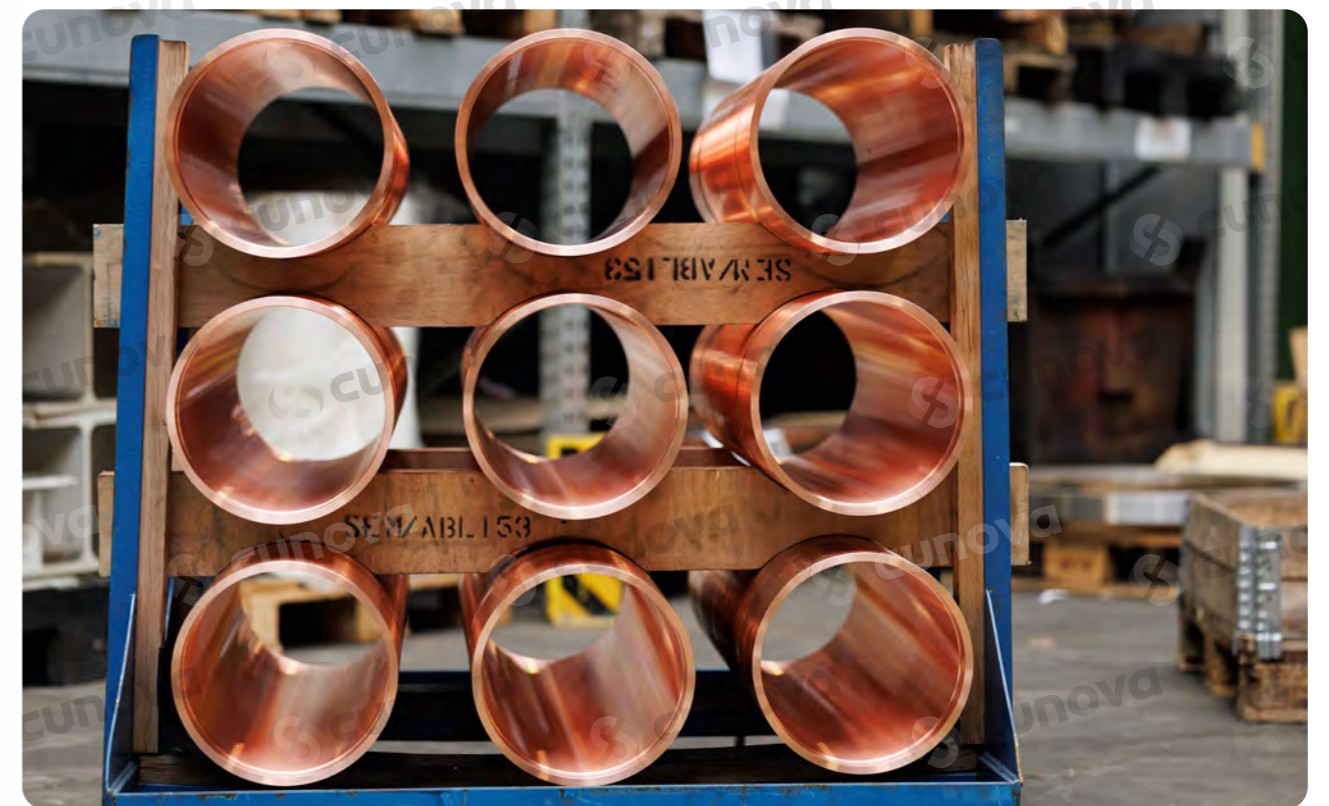

cunova after-sales Service

cunova mould materials developed and produced by cunova make it possible to implement copper materials that are ideally suited to customer requirements.

Moreover, the uncompromising cunova quality standard ensures that our customers are only supplied with products that are equal to this quality requirement.

To achieve high productivity and good product quality with the casting plant, other casting parameters must also be ensured, most notably those for maintaining and servicing the moulds. cunova after-sales service supports our customers in this regard by responding to technical questions and problems. Customer-specific service packages can also be negotiated as required.

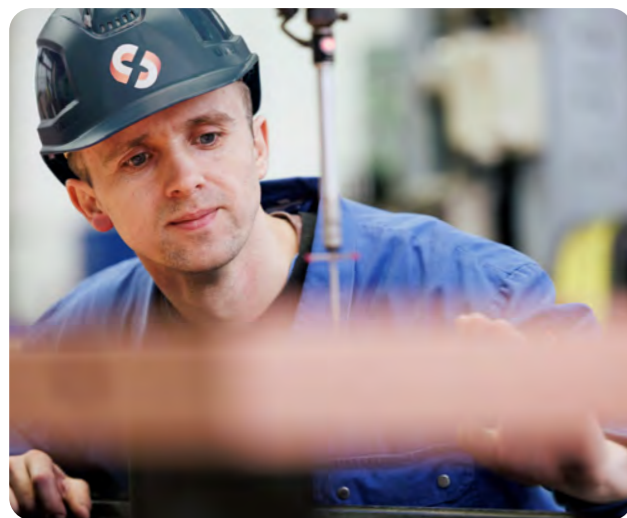

Forming

Close coordination between the casting process and the subsequent forming process is crucial to ensure optimal material properties and tight tolerances in production.

cunova has hot and cold rolling systems for forming the material in addition to systems for the forging, extrusion, and heat treatment of material.

Machining

Modern, precise CNC-driven machine tools are available for the final machining of moulds. The construction data of components used to produce the desired work-piece geometry is acquired using integrated CAD/CAM systems.

Quality assurance

Supplying high-quality components is an essential prerequisite of our business that assures our customers smooth, trouble-free plant operation. To ensure that our customers only receive high-quality components, all processes and operational procedures at cunova are certified in accordance with the DIN ISO 9000 series.

In addition to the analysis of materials, cunova has a wide range of test procedures such as ultrasonic and thermal fatigue testing as well as strength tests.



Typical Shapes

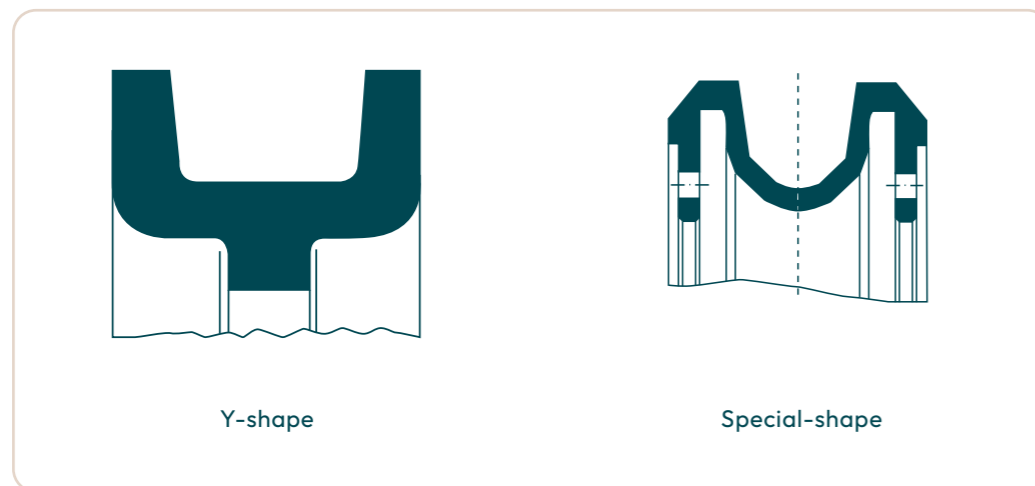
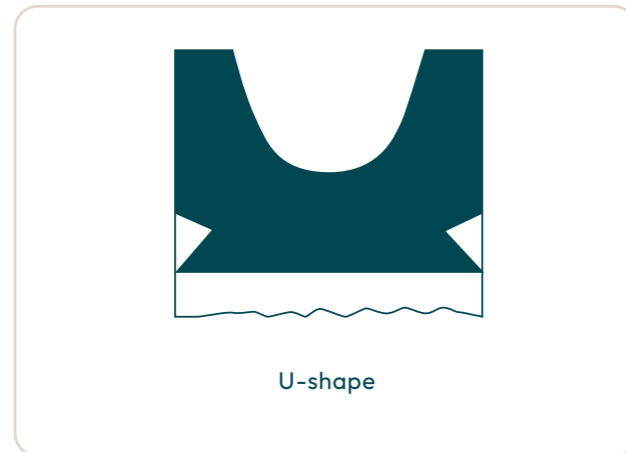

Manufacturing Range of cunova Casting Wheels

cunova covers the casting wheel size range from 600 to 4,200 mm (other dimensions on request). Thus cunova

can supply casting wheels in all nonferrous plants in the desired designs and materials.

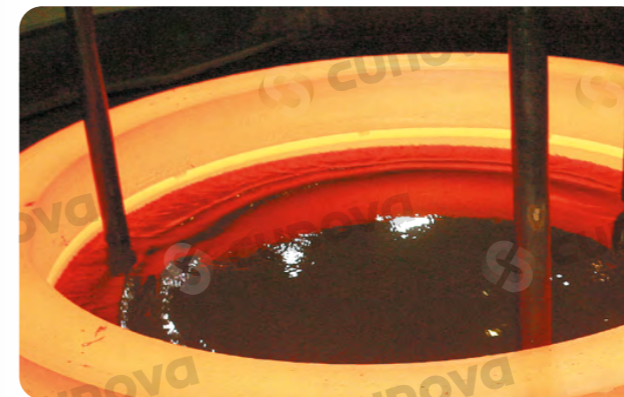
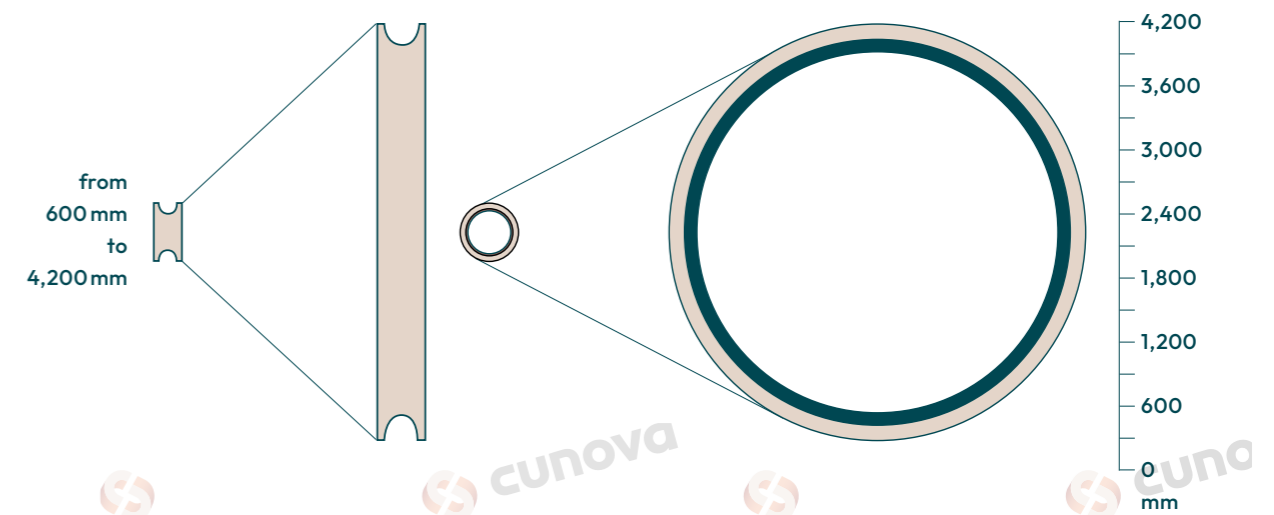



FORMERLY KME
SPECIAL PRODUCTS
& SOLUTIONS

**Further information on
Moulds for Casting nonferrous Alloys:**

T +49 541 321-3218
info@cunova.com
www.cunova.com

cunova GmbH
Klosterstrasse 29
49074 Osnabrück
Germany

cunova Service Center:



cunova GmbH

Tel. +49 541 321 3218 | M: info@cunova.com



cunova Service USA LLC

T: +1 814 827 7717 | M: sales@cunova.us



M: service@cunova.com



KME Magma Service

M: info@cunova.com



cunova Kalip Servis Sanayi ve Tic. A. Ş.

T: +90 212 244 7460 | M: cem.oz@cunova.com.tr



cunova Service India Pvt. Ltd.

T: +91 966 331 4751 | M: prashant@cunova.in



cunova Mould Mexico S.A. de C.V.

T: +51 818 308 6810 | M: luis.iracheta@cunova.mx



cunova Service Spain S.A.

T: +34 946 360 128 | M: info@cunova.es

® = registered trademark

All changes reserved. MCO290523.

Owing to limitations in printing technology, the colours reproduced in this brochure should be regarded as approximate equivalents to the colours described.